

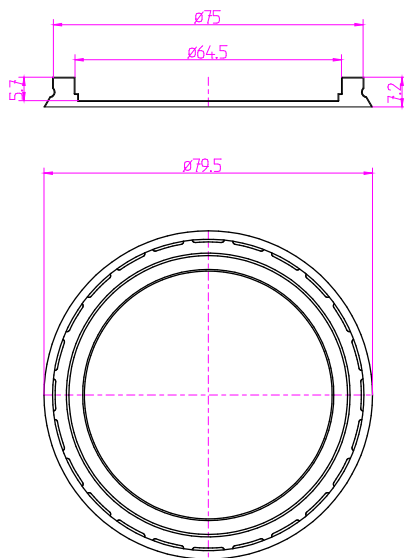

PS ROUND LID 75 DIA

- Odorless, Tasteless, Hygienic, Stable
- Suitable for direct-contact, Primary food packaging
- Recyclable, Environmentally friendly
- Cost-effective



Product Family

PET ROUND LID 75 DIA

Associated Products

ALL 75 DIA CUPS

Quality

All our products are produced in quality controlled environment taking into consideration food safety and hygiene standards under certified ISO 9001:2000 & ISO 9001:2008 and GMP quality management system. Our Quality System is regularly audited by third party.



Disclaimer

Consumer Safety is extremely important for Industrium. Therefore all our food-contact materials and articles are produced taking into consideration national and international regulations, and do not transfer their constituents to the food under normal or foreseeable conditions of use. The foregoing data are without engagement and constitute the best of our knowledge; they are reliable if applied correctly and adapted to local conditions and cannot be taken as any guarantee, since the processing at the end-user are beyond our control. The above mentioned guidelines are supplied to assist the buyer in determining the proper use of products. However, because every food supplier's recipes, ingredients, processes and supply chain are unique, these guidelines are not a substitute for product testing. Confirmation of product acceptability under customer's specific conditions of use must be done by the customer.

Properties

Material	:PS
Material composition	:98% Polystyrene 2% Master Batch
Manufacturing Process	:Thermoforming
Rim Diameter (mm)	:75
Total Height (mm)	:7.2
Product Weight (g)	:1.5
Color(s)	:White
Application	:Cold use
Microwavable	:No
Freezer compatible	:Yes
Dishwasher safe	:No
Number of uses	:Single
Softening Temperature (°C)	:90
Upper Temperature Limit(°C)	:70
Lower Temperature Limit (°C)	:-40
Printable	:Yes
Printing Area Approx. (mm)	:50

Packaging

Packaging	:Cardboard Carton
Pieces per Carton	:1500
Carton Width (cm)	:41
Carton Depth (cm)	:25
Carton Height (cm)	:50
Carton Weight (Kg)	:2.82

Storage & Handling Conditions

Dry Cool Space (<40°C)
Out of Direct Sunlight
Maximum stacking 4 Cartons

Ordering Option(s)

Unprinted/Printed